

STAAL SERVICE VLAANDEREN



STERK IN STAAL EN SERVICE



DAK & WAND

INDUSTRIEPARK NOORD II
ZANDVOORTSTRAAT 17
B-2800 MECHELEN
TEL. 0032 15 20 29 60
FAX 0032 15 20 29 30
EMAIL: SALES@STAALSERVICEVLAANDEREN.BE
WWW.STAALSERVICEVLAANDEREN.BE



STAAL SERVICE VLAANDEREN



TEKENT VOOR:

SERVICE KWALITEIT SNELHEID

DOOR:

- gemotiveerd personeel
- moderne infrastructuur
- centrale vestiging
- polyvalente opslagruimten
- ruime en brede voorraad
- eigen transport met kraanwagens

VOORWOORD

Wij hebben een uiterste zorgvuldigheid betracht bij de samenstelling van deze catalogus. Desondanks zijn fouten niet geheel uit te sluiten. Alle cijfers zijn slechts gegeven ter inlichting.

Wij sluiten, mede ten behoeve van al degenen die aan deze uitgave hebben meegewerkt, elke aansprakelijkheid voor een directe of indirecte schade uit, ontstaan door of verband houdende met toepassingen van deze publicatie.

De directie.





1. AFBEELDINGEN	3
2. DAK EN WANDPLATEN	4-5-6
3. BINNENDOZEN - STEELDECK Geplooide profielen	7
4. TOEPASSINGEN	8
5. AFWERKINGSPROFIELEN	9
6. COATINGS	10
7. BEVESTIGINGEN	11

1. AFBEELDINGEN DAK EN WANDPLATEN





GOLFPLATEN



PANELEN IN DAKPANVORM VOOR
OUDE DAKEN & NIEUWBOUW

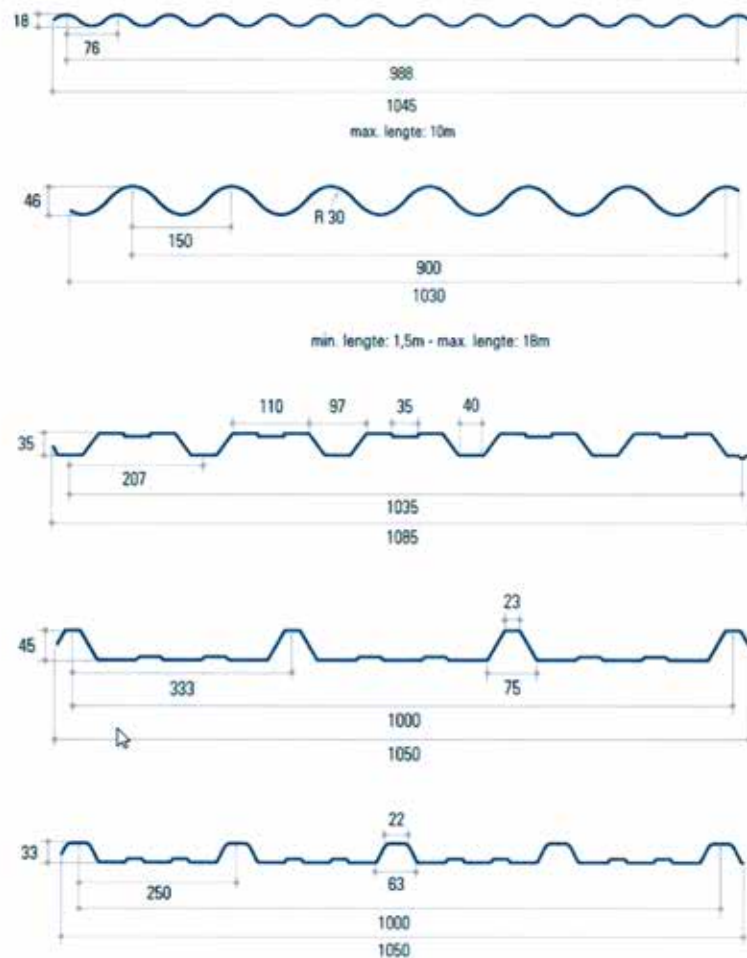



**DAK-SANDWICHPANELEN
PUR - SCHUIM**

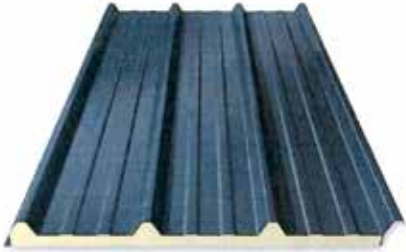

**WAND-SANDWICHPANELEN
PUR - SCHUIM**



**DAK-PANELEN
STEENWOL**

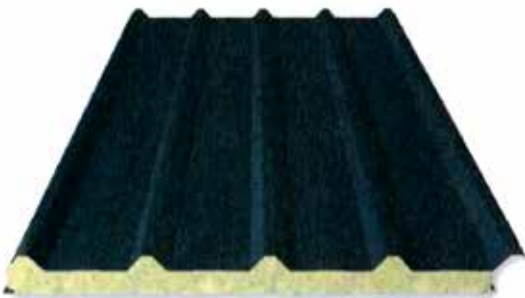

**WAND-PANELEN
STEENWOL**



LICHTSTRAAT-SANDWICHPANELEN

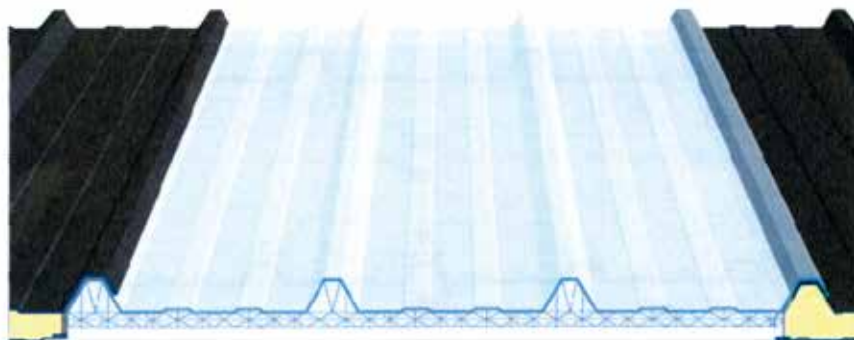



Kleuren



BRUIN / BRONS



ANTRACIET



TERRACOTTA (RAL 8004)



ZWART



ROOD



ZWART BLINKEND HOOGGLANS
(RAL 9005)

LICHTPLATEN

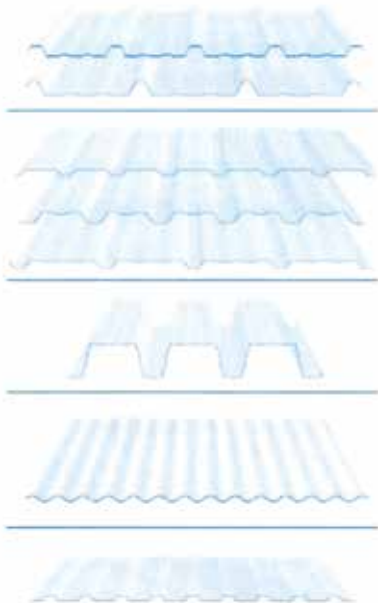

OPTISCH PROFIEL VOOR POORTEN



ANDERE TYPES PLATEN OP AANVRAAG VERKRIJGBAAR





BINNENDOZEN

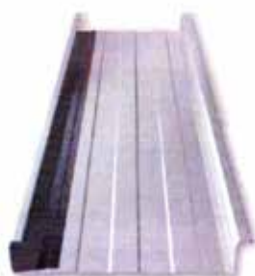

GEPERFOREERDE BINNENDOZEN

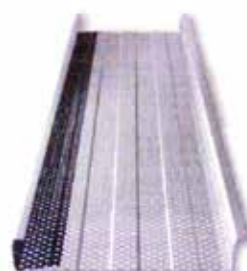

**STEEL-DECK
GEPERFOREERDE ONDERDAKPLATEN**

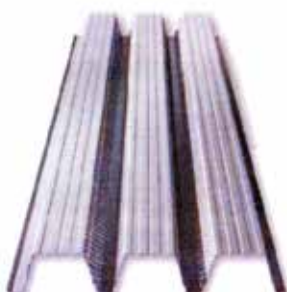

**STEEL-DECK
ONDERDAKPLATEN**

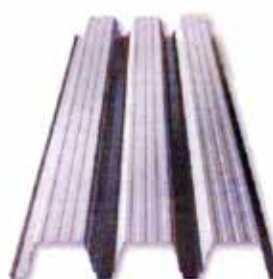

GALVA-Z-PROFIELEN



GALVA-SIGMA-PROFIELEN



GALVA-C-PROFIELEN



GALVA-OMEGA-PROFIELEN



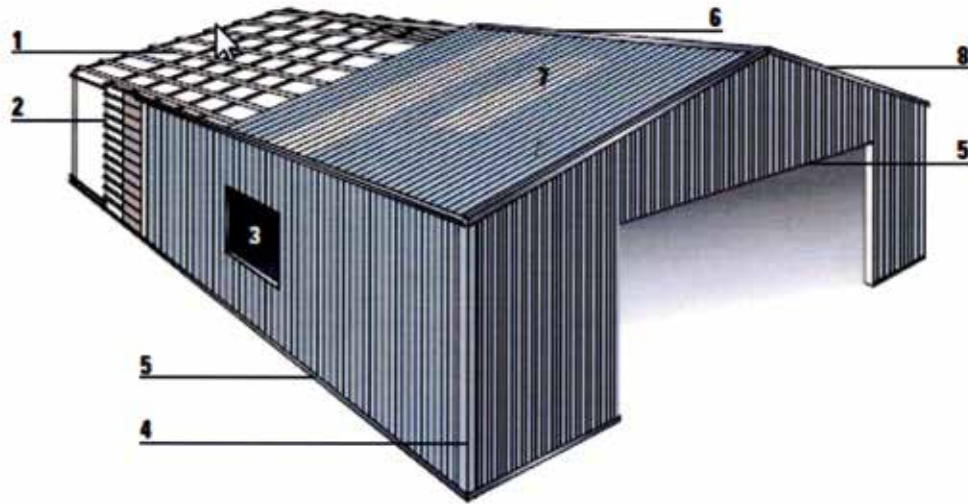

Z-GORDINGEN



BINNENDOZEN VOOR
GEÏSOLEERDE DUBBELE WAND

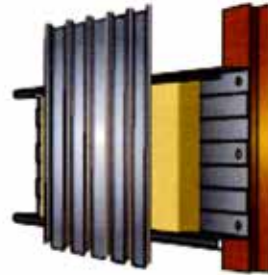

UITSPARINGEN



BUITEN- EN BINNENHOEKEN

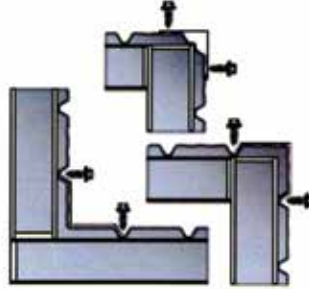

DRUIPLIJSTEN



NOKKEN

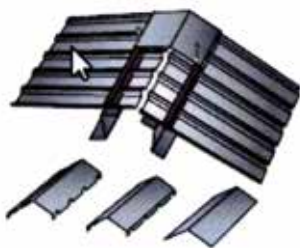

LICHTSTRATEN



WINDVEREN





GETANDE MUURNOKKEN

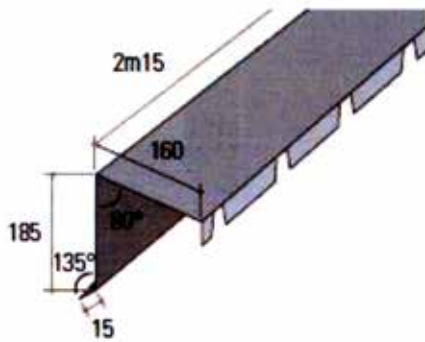

OPSTAANDE
GETANDE MUURNOKKEN

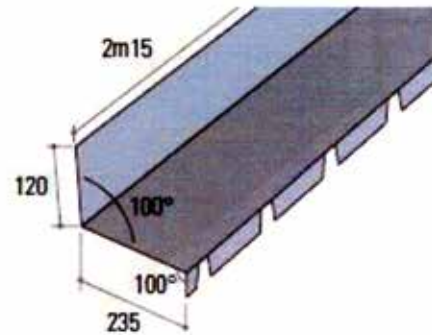

GETANDE NOKKEN

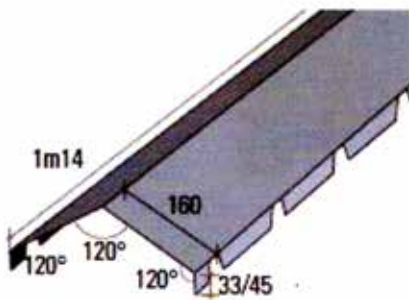

PLATTE NOKKEN

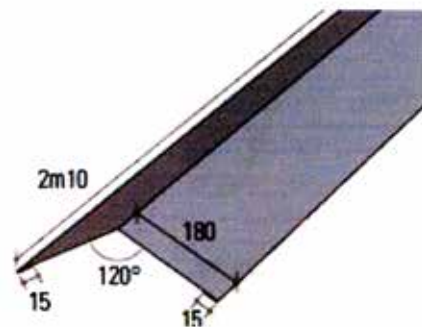

WINDVEREN

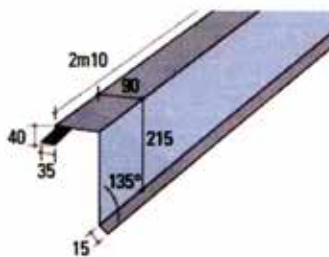

HOEKPLATEN

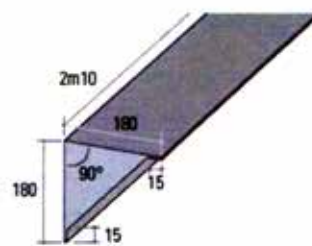

DRUIPLIJSTEN

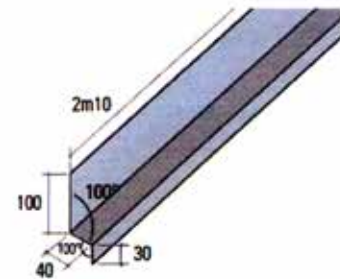

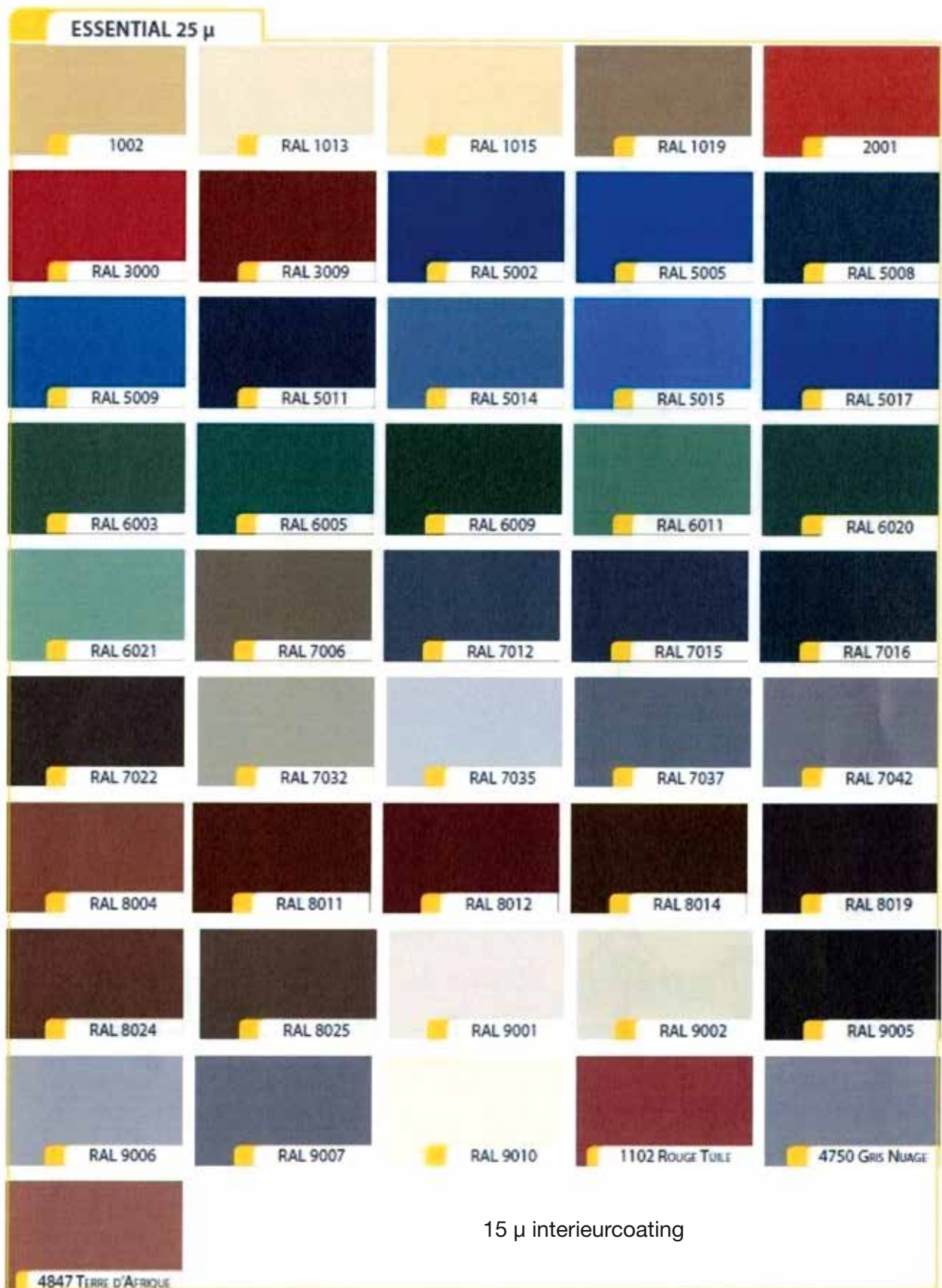

Andere kleuren en coatings ook mogelijk.





**ZELFBORENDE
METAALSCHROEVEN**



HOUTSCHROEVEN



CORRECT

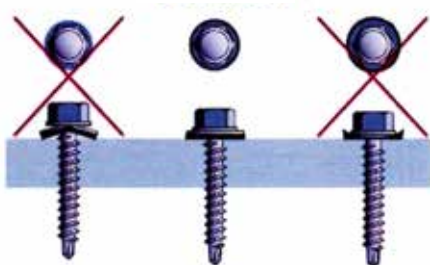

HAAKBOUTEN



STEUNBEUGELS



STAAL SERVICE VLAANDEREN



INDUSTRIEPARK NOORD II
ZANDVOORTSTRAAT 17
B-2800 MECHELEN
TEL. 0032 15 20 29 60
FAX 0032 15 20 29 30
EMAIL: SALES@STAALSERVICEVLAANDEREN.BE
WWW.STAALSERVICEVLAANDEREN.BE

